

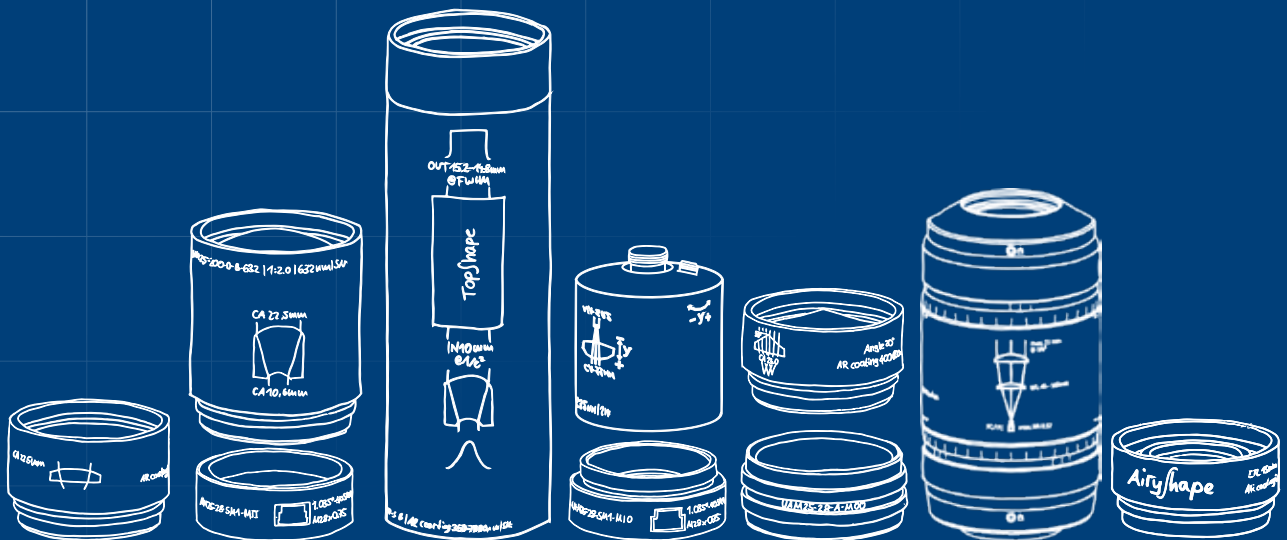

Beam Tuning

**Beam expansion and
Beam shaping** at the next level



Discover plug and play perfection.

asphericon BeamTuning

asphericon BeamTuning for beam expansion, fiber collimation and beam shaping at the next level. Discover a comprehensive range of laser beam processing elements, the various possible combinations and compile your own individual product selection.

BEAMEXPANSION

The world's first aspheric beam expansion system is the right choice when it comes to beam expansion or reduction with outstanding quality.

BEAMEXPANSION PRODUCTS:

- = a|BeamExpander (p. 6)

FIBERCOLLIMATION/FIBERCOUPLING

Use our adjustable fiber collimation packages to easily combine all BeamTuning elements directly to your fiber coupled laser source.

FIBERCOLLIMATING PRODUCT:

- = a|AspheriColl (p. 8)
- = a|VariColl (p. 10)

tu·ning ['tju:nɪŋ],
to adjust something for maximum usability or performance



= Flexible choice of input and output beam diameter

= Economical to use – Simple integration into any optical system by an intelligent mounting concept

= Low contamination due to tightly sealed mountings

= Easy and timesaving handling



BEAMSHAPING

Simply transform collimated Gaussian laser beams into collimated and focused Top-Hat beams and take advantage of the easy handling.

BEAMSHAPING PRODUCTS:

- = a|TopShape, a|TopShape LDX (p. 12)
- = a|AiryShape, a|SqAiryShape (p. 14)

COMPLEMENTARY ELEMENTS

Connect all elements or combine them with other systems. Matching adapters and MountedOptics allow for 100% flexibility.

COMPLEMENTARY PRODUCTS:

- = a|Adapters & Optomechanical components (p. 17)
- = a|MountedAspheres/Axicons (p. 20)

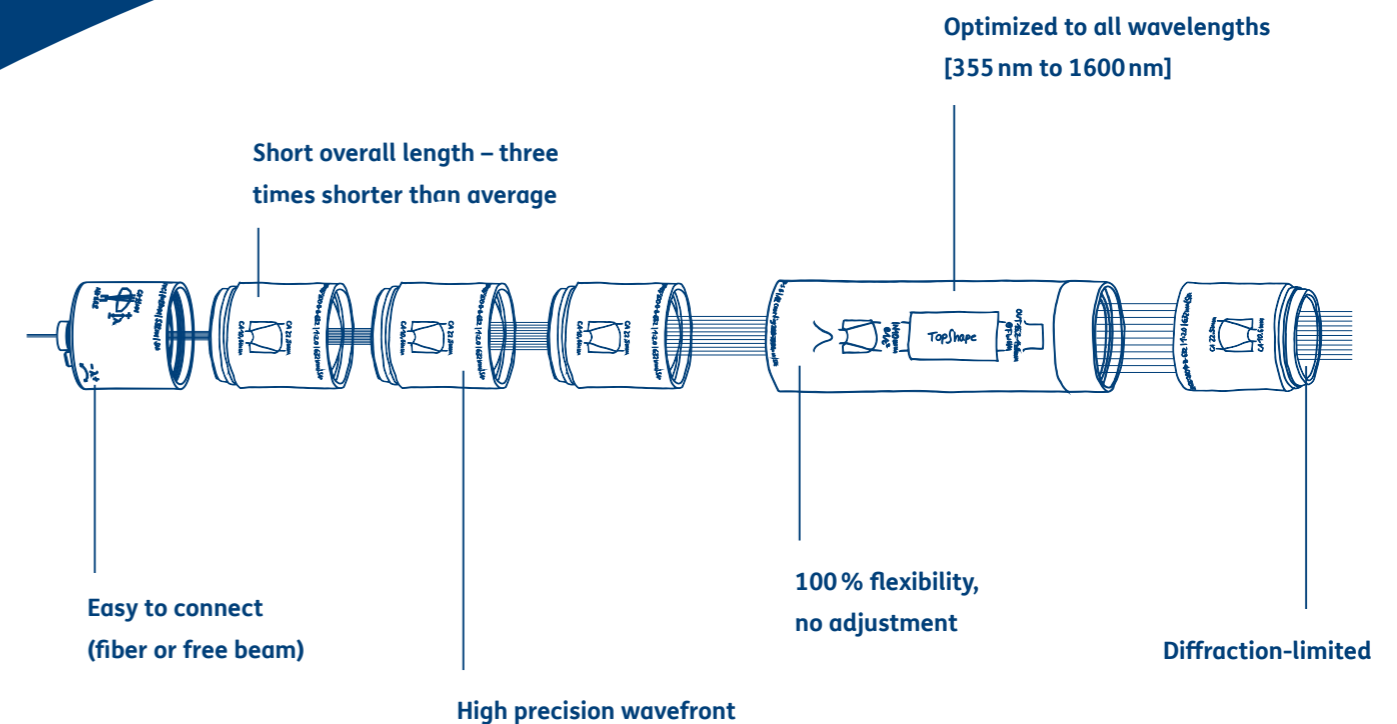

Application areas

Discover the wide application range of our BeamTuning products. Flexible in use, with the highest quality, ideal for your specific needs. Below you find some selected examples. Need help with an individual solution? Let us know!

LABORATORY

Beam expansion and beam shaping systems are used for optimum beam adaption between light sources (i.e. laser) and a following optical element. Accurate illumination of the optically effective surfaces is especially essential for beam shaping and focusing with high numerical apertures. Conventional systems can only be adapted with high effort, are relatively large and only suitable for a certain wavelength.

BeamTuning by asphericon covers a wide wavelength range with just a few products, enables flexible adjustments and saves you a lot of time.

Discover, for example, how the a|BeamExpander can help you reduce the overall length of your beam expansion system and still achieve outstanding performance results.

→ Learn more on page 6/7.

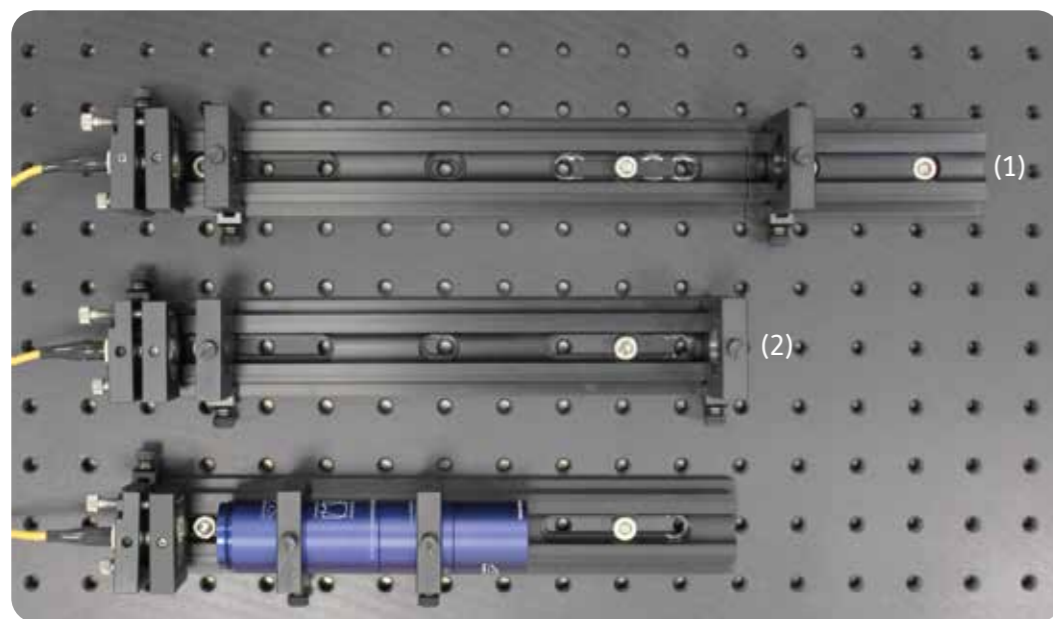

Magnification (M = 10) with a|BeamExpander compared to conventional systems (1) Kepler and (2) Galileian.

High-end BeamTuning solutions for your application.

MATERIAL PROCESSING

If a laser beam with a Gaussian intensity profile is used, e.g. for drilling or cutting, the energy loss at the edge of the beam affects the cutting edge quality of the workpiece. Good results require further cuts, which influence the efficiency of the process. In the case of surface functionalization, a Gaussian distribution is also disadvantageous, since uneven melting of the surface prevents homogeneity. Discover how BeamTuning elements easily generate homogeneous intensity distributions (e.g. Top-Hat or Donut). The latter allows for a uniform heat input into the material, which results in smooth profiles.

→ Learn more on page 14/15.



Surface functionalization with conventional system (Gaussian Beam)



Surface functionalization with a|AiryShape (Top-Hat)



Surface functionalization with a|AiryShape (Donut)

Image reference: Otto Schott Institute of Materials Research (OSIM) at the Friedrich Schiller University of Jena

IMAGING/ILLUMINATION

The uneven illumination of Gaussian intensity profiles makes quantitative analysis in laser-based wide-field fluorescence microscopy highly challenging. One disadvantage of non-uniform illumination is the uneven activation of molecules. Those being closest to the center of the beam fluoresced more strongly than those near the periphery. Discover how BeamTuning by asphericon allows to achieve uniform illumination (homogeneity > 95 %) while remaining tolerant to variations in size of the incoming laser beams.

→ Learn more on page 12/13.

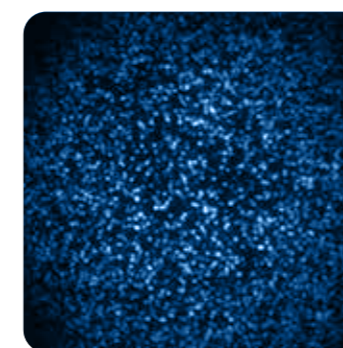

Conventional illumination system

Paper Download:

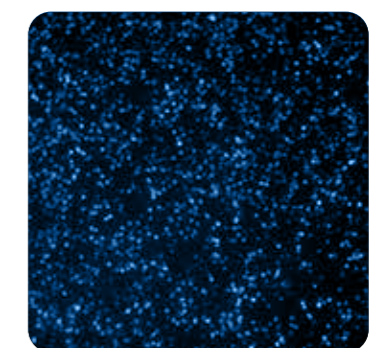

Illumination with a|TopShape

Image reference: I. Khaw, B. Croop, J. Tang, A. Moehl, U. Fuchs, K. Y. Han: „Flat-field illumination for quantitative fluorescence imaging“, In: OPTICS EXPRESS, Vol. 26, No. 12, 11 Jun 2018, pp. 15276-15288

a|BeamExpander

Discover the world's first aspheric and diffraction-limited beam expander. The a|BeamExpander is a monolithic laser accessory with just one aspheric lens for the highest level of precision. Experience nearly endless possibilities with up to 32× beam magnification and optimized performance for different design wavelengths – individually measured and certified.



- = Available with magnifications of 1.5 | 1.75 | 2.0
- = Max. input aperture 10.6–14.7 mm, max. output aperture 22.5 mm
- = Available in five design wavelengths [355 nm / 532 nm / 632 nm / 780 nm / 1064 nm]
- = Possibility of combining up to five expander for up to 32 times beam expansion and over 230 intermediate stages
- = Completely diffraction-limited – individually measured and guaranteed by an original asphericon certificate
- = Laser induced damage threshold (Coating): 12 J/cm², 100Hz, 6 ns, 532 nm
Like all BeamTuning elements all a|BeamExpander come with a broadband coating. For higher laser power applications please request a V-Coating. Contact us for an individual offer. Please note the material damage threshold of your set-up!

Also available as UV version, made of Suprasil and optimized for Nd:YAG-Laser [355 nm], which enables diffraction-limited beam expansion in the UV range.

APPLICATION

A beam expander is used to increase or decrease the diameter of a collimated input beam to a larger or smaller collimated output beam. Use the a|BeamExpander for applications such as interferometry, telescopes, or microscopy.

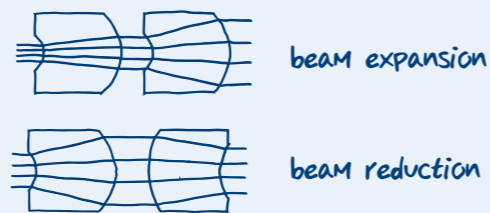

TECHNICAL DIMENSIONS

a|BeamExpander [532 – 1064 nm]

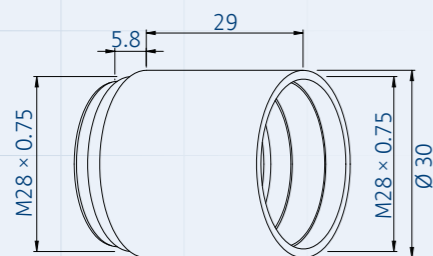

a|BeamExpander UV [355 nm]

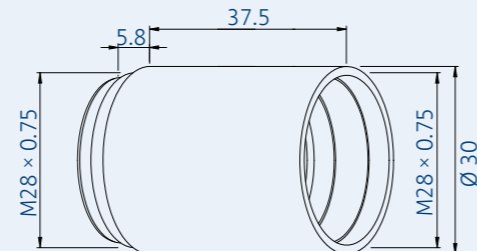

LENGTH

The a|BeamExpander, based on the use of aspheric and monolithic beam expansion elements, achieves overall lengths up to 50% shorter than those of conventional systems – even when used in a cascade. Shown are a Kepler and Galilei telescope with 10× magnification (M = 10) in comparison with our beam expansion system.

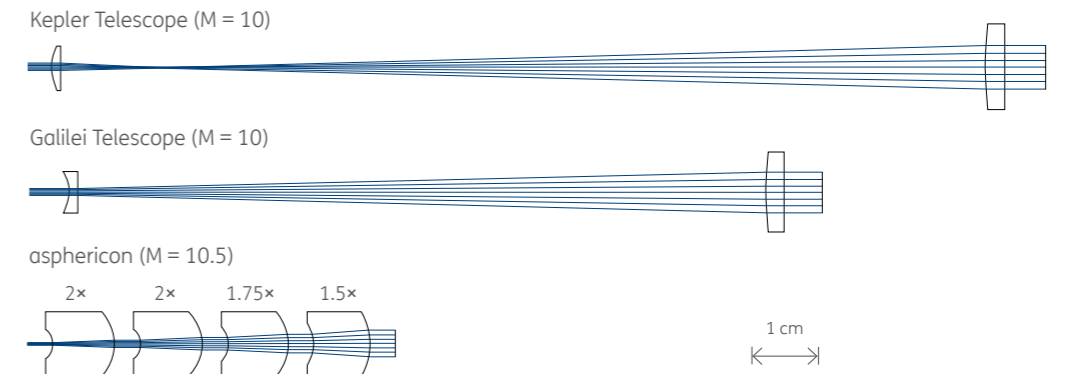

PERFORMANCE

Its high performance is particularly evident regarding the wavefront measurements. Depicted are the measured wavefront maps of an a|BeamExpander with a magnification M = 2 (left) and a five element set of a|BeamExpander with M = 21 (right) at 532 nm. The aspheric element is made of glass by grinding and polishing the surface. Having values of wavefront RMS = 0.018 λ (left) and RMS = 0.040 λ (right) prove the exceptional precision of the lenses and its well-suited use in a cascade system.

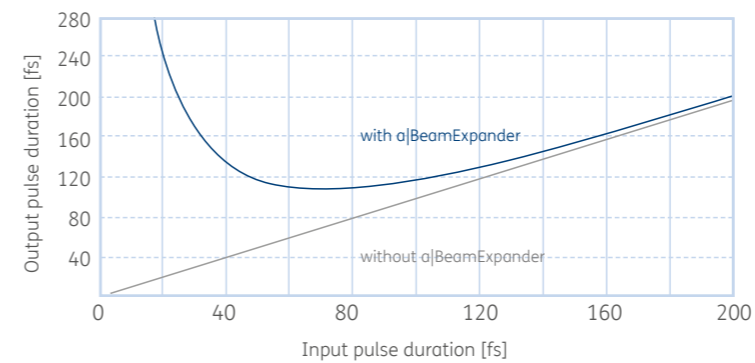
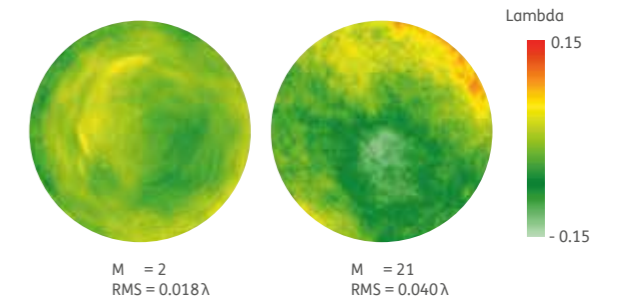

FLEXIBILITY

The a|BeamExpander can also be used flexibly in the wavelength range from 500 nm to 1600 nm for ultra short pulse laser applications. Please be aware of the pulse broadening effect. In the chart on the left, you can see how your input pulse changes by propagating through an optical element such as the a|BeamExpander.

a|AspheriColl

Now even easier to adapt: the a|AspheriColl, an adjustable fiber collimation device, which enables the perfect connection of FC/PC patch fibers to your set-up. Combine the world's smartest off-the-shelf fiber collimator for NAs up to 0.275 with BeamTuning or other beam shaping elements to obtain any desired output beam while maintaining a diffraction-limited wavefront.



- = Fiber collimator covering for NAs up to 0.275
- = Focal length: $f = 20\text{ mm}$, with $\varnothing_e = 11.5\text{ mm}$
- = Optimized for wavelength range 355 nm - 1600 nm
- = Simplified wavelength adaption by setting adjustment unit with SW2 allen key
- = Perfectly aligned lateral position
- = Completely diffraction-limited performance (Strehl > 0.95) when used with FC/PC patch fibers
- = Thanks to matching adapters also usable for APC fibers
- = No truncation effects compared to other available fiber couplers
- = Thanks to bigger output beam diameters, no additional expansion might be needed (shorter system length)
- = Laser induced damage threshold (Coating): 12 J/cm^2 , 100Hz, 6ns, 532nm
For higher laser power applications please request a V-Coating. Contact us for an individual offer.

APPLICATION

Easily use a|AspheriColl to collimating or coupling fibers.

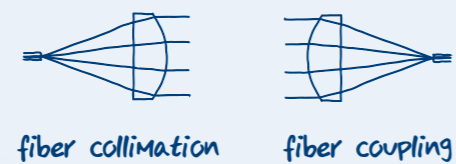

TECHNICAL DIMENSIONS

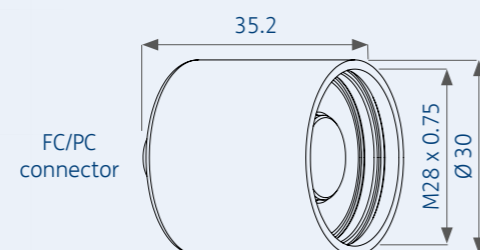

PERFORMANCE

The map on the right shows the measured wavefront of an a|AspheriColl at 632 nm. The diameter of the collimated output beam, which depends on your fiber's numerical aperture (NA) and mode field diameter (MFD), is already in a usable range. It is already perfectly aligned to the design wavelength. If needed, it can also be adjusted in a certain wavelength range. Due to its outer diameter of 30 mm the a|AspheriColl fits into any standard holder (e.g. from OWIS). By simply plugging in the fiber, the a|AspheriColl is ready to use.

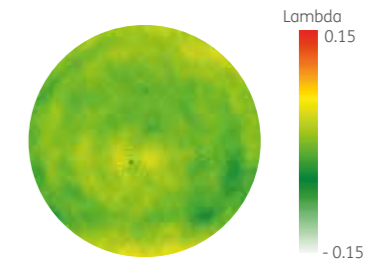

FLEXIBILITY

The diameter of the collimated output beam generated by an a|AspheriColl depends on the NA and MFD of the fiber. Both are functions of the wavelength.

Due to fiber manufacturing process, the MFD might deviate from its nominal value. The figure shows collimated output beam diameter as a function of MFD and NA for the a|AspheriColl. The large output beam diameter is advantageous, since there are no truncation effects compared to other available types of fiber couplers.

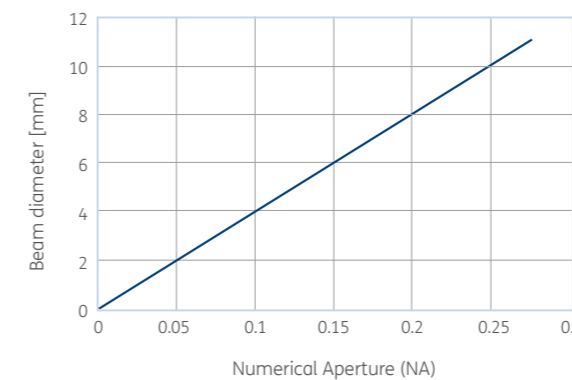
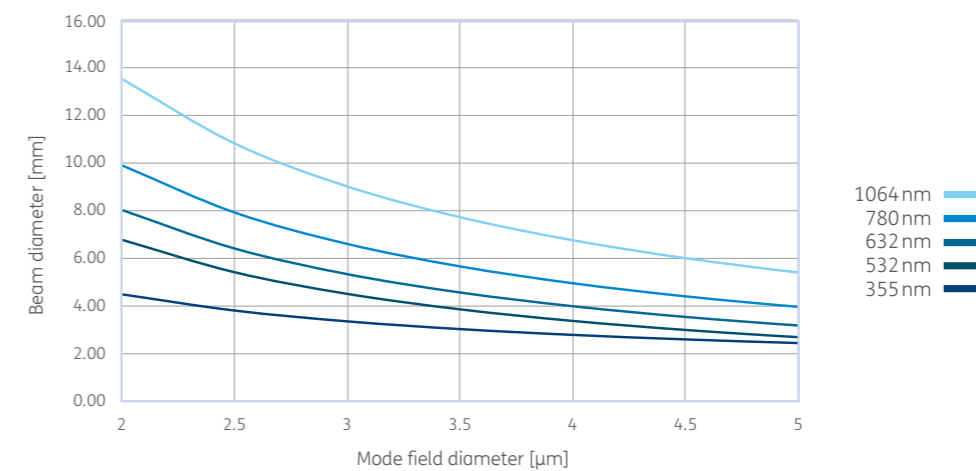

The basic diameter is set as shown in the graph on the left. The a|AspheriColl collimates the output of single mode fibers with NAs up to 0.275 for the wavelengths [nm] 355, 532, 632, 780 and 1064.

a|VariColl

NEW

Discover asphericon's latest fiber collimation device, the a|VariColl - generating the perfect input conditions for all following beam shaping optics. The adjustable EFL allows compensation of variations in the fiber NA. Thanks to the most precise optics as well as a sophisticated optical and mechanical design, modifications of beam size and divergence angle can be performed independently and without any effort. The a|VariColl impresses with a compact design and allows finest adjustments for output beam diameter and divergence in applications with FC/PC patch fibers.

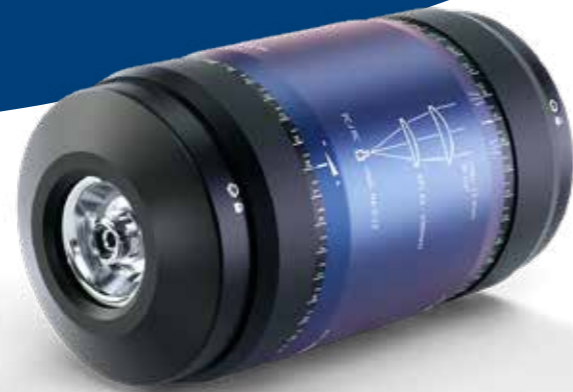

- = Effective focal length 47 – 99 mm
- = Obtain collimated beam with 10 mm diameter for fiber NAs in range of 0.055 to 0.12
- = Available in four design wavelengths [532 nm / 632 nm / 780 nm / 1064 nm]
- = Large spectral range: 500 nm to 1200 nm
Wavelength range for diffraction-limited collimation see page 23.
- = Generation of collimated diffraction-limited beams up to 11 mm $1/e^2$ with RMS wavefront error < 50 mλ
- = Adjustable beam diameter while keeping constant divergence at design wavelength
- = Precise adjusting of divergence is also possible
- = Perfect for illumination of a|TopShape, a|AiryShape and a|SqAiryShape, as separate adjustment of divergence and beam diameter allows perfect input conditions
- = Laser induced damage threshold (Coating): 12J/cm², 100Hz, 6ns, 532nm

APPLICATION

Easily use the a|VariColl to collimate and couple fibers while separately adjusting divergence and beam diameter.

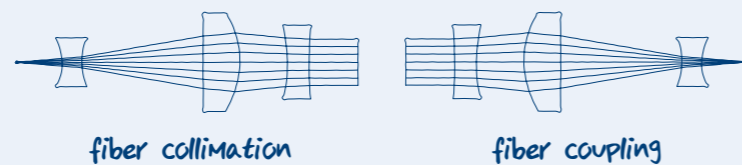

TECHNICAL DIMENSIONS

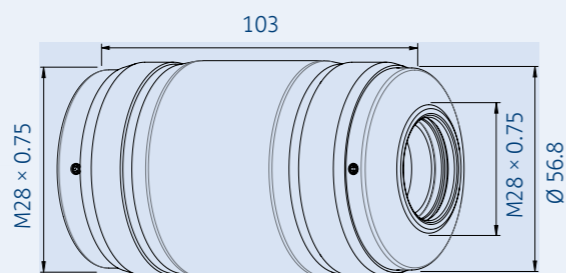

FLEXIBILITY

The a|VariColl is designed to compensate for variations in the numerical aperture of fibers due to their manufacturing tolerances. For NAs from 0.055 to 0.12 an output beam with a $1/e^2$ maximum diameter of 11 mm can be achieved in diffraction-limited quality. For NAs below 0.12 this can also be achieved for smaller beam diameters.

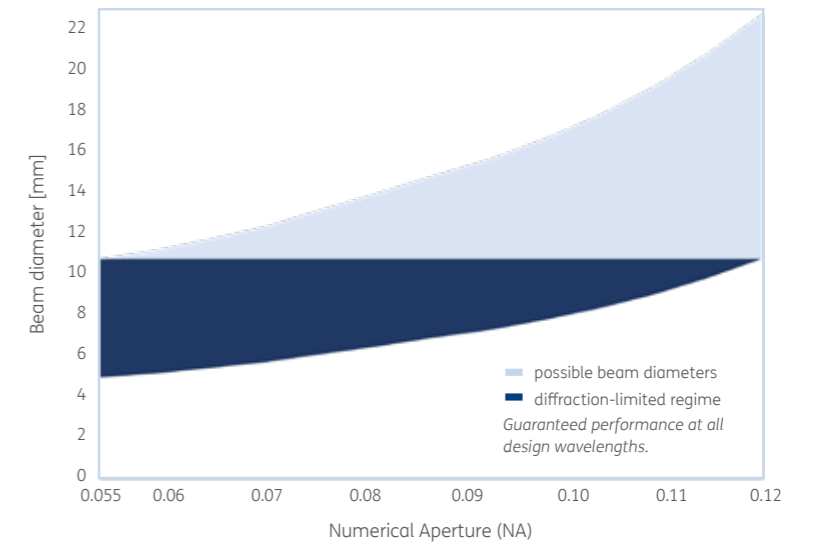

PERFORMANCE

Looking for a solution to smoothly change the EFL of your fiber collimator while still easily connecting the patch fiber to your set-up? Shown are the measured wavefront and intensity profile of an a|VariColl 532 nm. Use the a|VariColl to precisely tune the beam diameter. One of its key features is that a once collimated beam stays collimated, no matter which beam diameter you chose. The a|VariColl generates a diffraction-limited wavefront and is thus fully companionable with the BeamTuning line. It is a perfect match for the a|TopShape, the a|AiryShape and the a|SqAiryShape, as it can create flawless input beam conditions due to the separate adjustment options.

Measurement equipment:
Phasics SID4-HR-307c,
207x207 pts
Wavelength: 532 nm

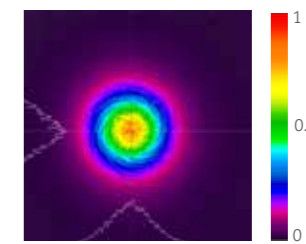
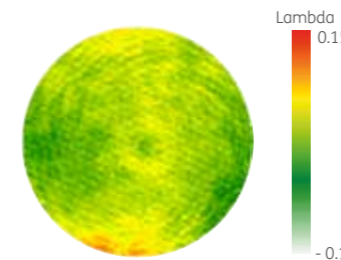

Measurement equipment:
Ophir SP90320
Wavelength: 532 nm

a|TopShape

Discover beam shapers, which easily transform collimated Gaussian beams into collimated Top-Hat beams. Available in three versions the a|TopShape convinces with a very compact design and unbeatable optical performance. For beam profiles up to 300 mm and as LongDistance (LD) variant for up to 1.5 m, the beam shaper accepts varying input beam diameter up to $\pm 10\%$. With the a|TopShape LDX the beam profile can be shifted to large working distances of up to 3 m by adjusting the input beam diameter.



- = Unbeatable optical performance (beam uniformity up to 0.05) without any power losses
- = Large spectral range (320 nm to 1600 nm) and suitable for multi-wavelength applications
- = Propagation depth (with beam uniformity < 0.1):
 - a|TopShape at least 300 mm
 - a|TopShape LD up to 1.5 m
 - a|TopShape LDX at least 1.5 m, shiftable to larger working distances
- = Input beam diameter:
 - @ $1/e^2 = 10$ mm ($\pm 10\%$) for a|TopShape & a|TopShape LD
 - @ $1/e^2 = 10.0 - 10.4$ mm for a|TopShape LDX
- = Output beam diameter @ FWHM = between 15.2 mm and 15.7 mm
- = Laser induced damage threshold: 12 J/cm², 100 Hz, 6 ns, 532 nm
For higher laser power applications please request a V-Coating. Contact us for an individual offer.
- = Find the right a|TopShape for your application:

NEW:
a|TopShape LDX
variable working distances.

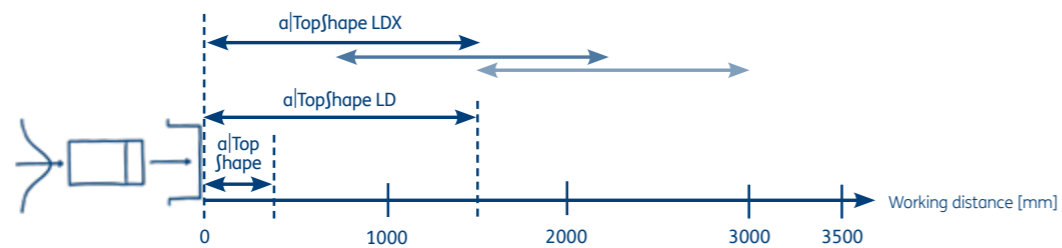

APPLICATION

a|TopShape is the perfect support for your application, e.g. in the field of metrology, microscopy or material processing.

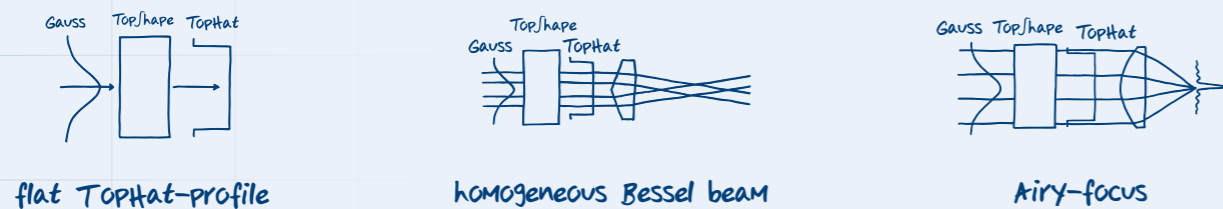

TECHNICAL DIMENSIONS

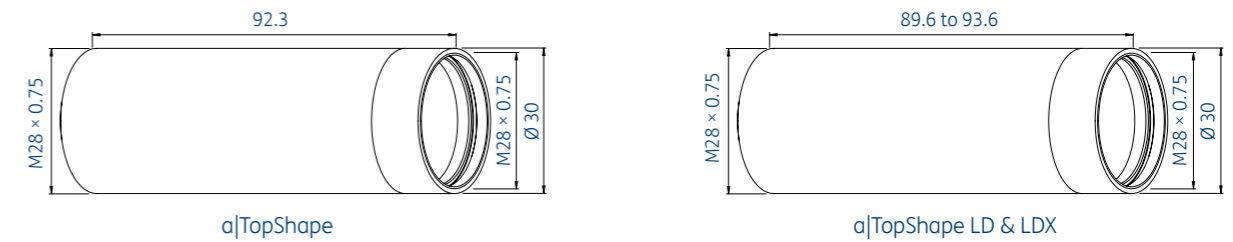

PERFORMANCE

The figure on the right shows the measured wavefront, using the a|TopShape, after passing 14 surfaces, incl. seven aspheres at a working distance of 100 mm. The resulting RMS wavefront error of 0.05λ , which corresponds with a Strehl value of 0.9, proves the high optical quality.

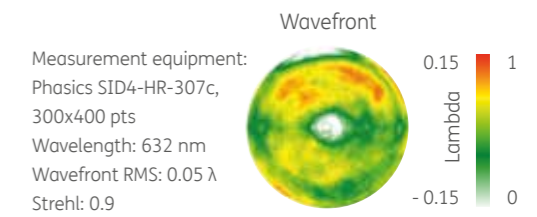

FLEXIBILITY

The outstanding feature of a|TopShape LD and LDX is their long and stable propagation distance. The figure below displays the intensity distribution at a working distance of 100 mm, 1000 mm, 3000 mm and 4000 mm. It is characterized by a homogeneity of 0.05 up to 1500 mm for both beam shapers. By varying the input beam diameter, a beam uniformity of 0.06 even up to 4000 mm can be guaranteed for the a|TopShape LDX.

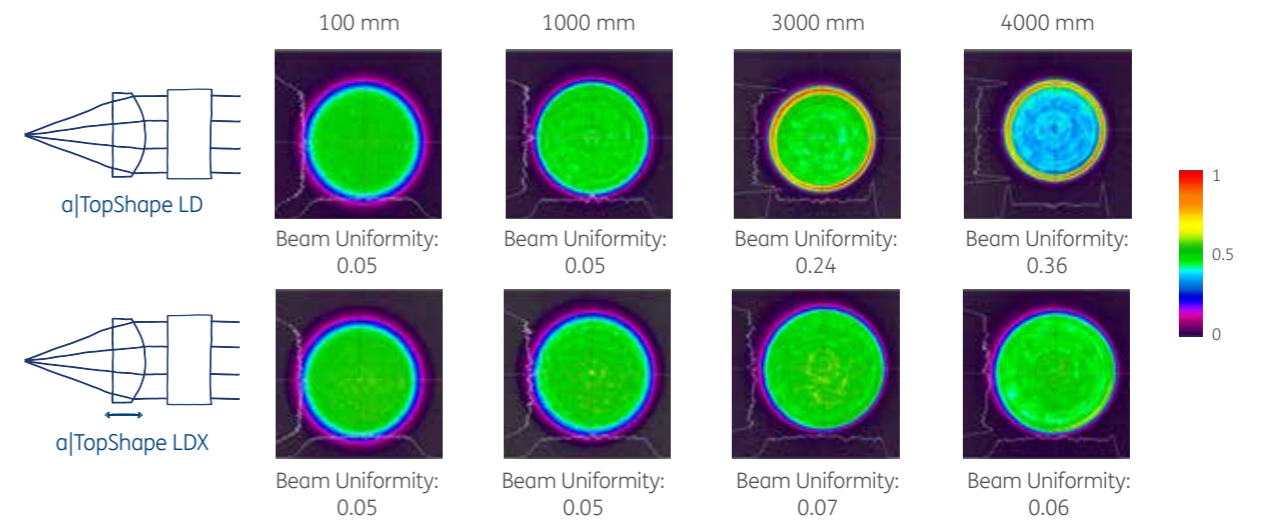

The a|VariColl is the ideal collimator for shifting the working range of the a|TopShape LDX due to its flexible output diameter. For more information on the a|VariColl, please refer to p. 10/11.

a|AiryShape, a|SqAiryShape

Want to generate focused round or squared beam profiles, like Top-Hat or Donut? No problem with a|AiryShape and a|SqAiryShape! Optimized for wavelengths from 300 nm up to 1600 nm, these beam shapers enable, in combination with a focusing lens, the transformation of collimated Gaussian beams into different focused round (a|AiryShape) and squared (a|SqAiryShape) beam profiles. Thanks to their compact designs, both beam shaping elements can be easily integrated into existing set-ups.

- = Generation of different round and squared beam profiles
- = Profile size easily scalable by focal length
- = Optimized for wavelengths from 300 nm to 1600 nm
- = Easy integration into existing set-ups
- = Perfect alignment by high-precision mounting
- = Compact design
- = Input beam diameter @ $1/e^2 = 10\text{ mm}$; output beam diameter $d_{\text{Airy}} = 10\text{ mm}$
- = Laser induced damage threshold: 12 J/cm^2 , 100 Hz, 6 ns, 532 nm
For higher laser power applications please request a V-Coating.
Contact us for an individual offer.
- = Usable for applications in the following beam diameter range:

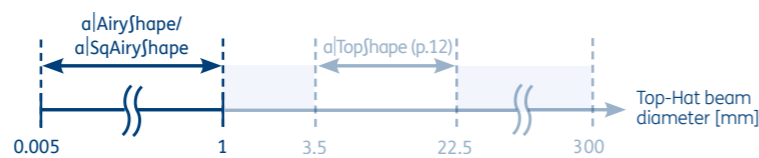

APPLICATION

Conveniently use these perfectly aligned BeamTuning elements for your application, e.g. in the fields of material processing or medical applications.

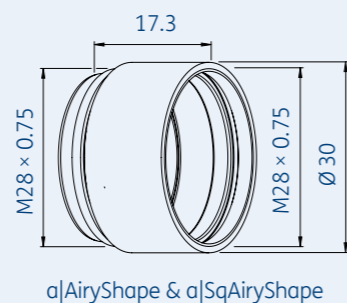
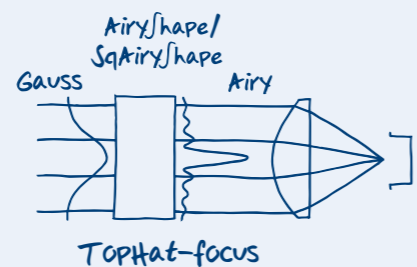

TECHNICAL DIMENSIONS

PERFORMANCE

In the figure below, beam profile cross sections along its propagation direction (z-axis) of the a|AiryShape are summarized in one diagram. The detection range covers 10 raylight lengths. Furthermore, the corresponding most interesting intensity profiles of the different working planes are shown as 2D and cross-sectional plots. The width of the profiles scale with beam waist w_0 of the focused beam.

According to the working principle of the a|AiryShape, it is possible, not just to generate one Top-Hat beam profile in the focal plane of a focusing lens but also to create various profiles in different working distances for your flexibility.

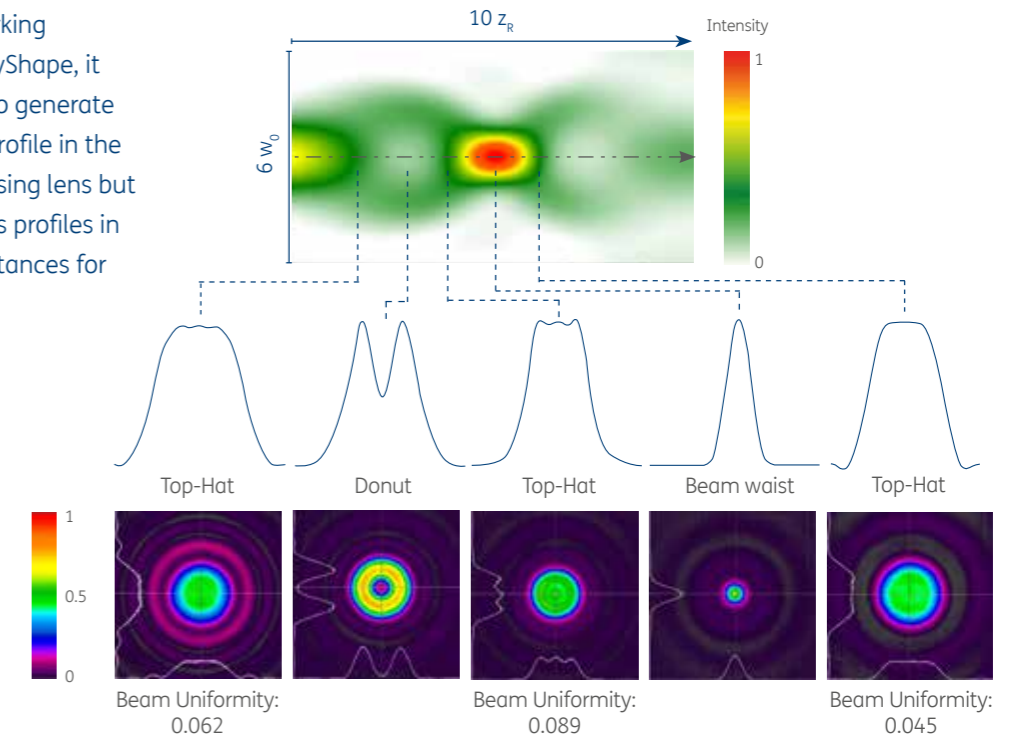

The following figure shows beam profile cross sections of the a|SqAiryShape, as well as its intensity profiles in the different working planes. Due to the working principle of the a|SqAiryShape, not only one squared Top-Hat profile is generated in the focal region, but a variety of profiles with four-fold symmetry.

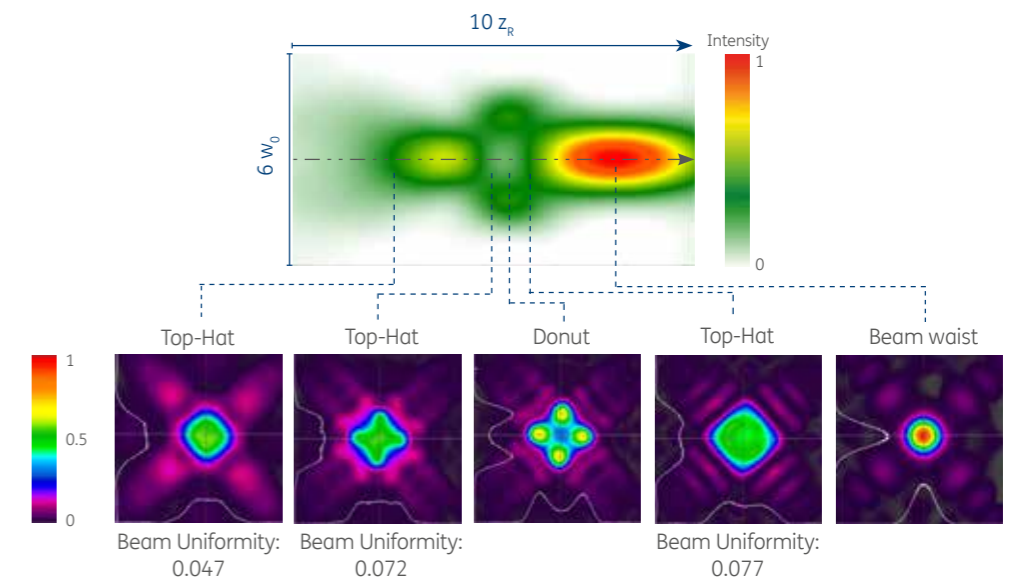

The generation of all shown beam profiles depends on the input beam quality. For optimum results a perfect collimated beam with minimized wavefront aberrations is required.

Shape it 'til you make it!

LENGTH & FLEXIBILITY

a|AiryShape and a|SqAiryShape have extremely compact designs. With lengths of only 17.3 mm, the beam shapers can easily be integrated into existing set-ups. Thanks to the optical design, the working distance can be reduced by a subsequent a|BeamExpander without altering the size of the focal intensity distribution. The example system (1) has an overall length of 290 mm. By using another a|BeamExpander (2), the length can already be reduced by 25 %, since shorter focal lengths can be used. With more a|BeamExpanders total system reductions of up to 75 % are possible.

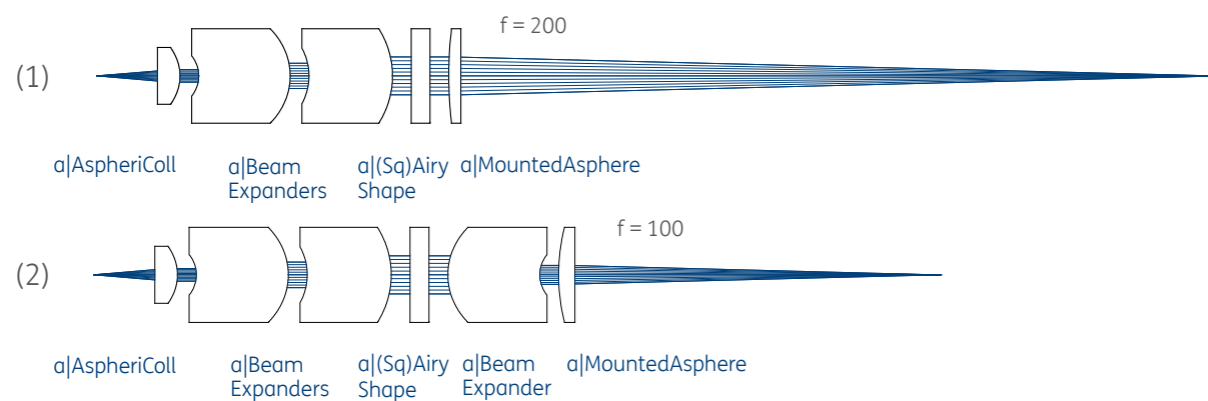

SIZE OF THE TOP-HAT BEAM PROFILE

a|AiryShape and a|SqAiryShape are based on a modular approach, thus, only the number of elements, which are really necessary for the application, are added to the set-up. The overall length of the systems can be kept as small as possible. Following formula can be used to roughly estimate the size of the Top-Hat beam profile:

$$d_{FWHM} = 2.44 * \frac{f * \lambda}{D}$$

D = Input beam diameter
 d = Top-Hat beam diameter (FWHM)
 f = Focal length



a|Adapter

Cross-system and intra-system a|Adapters conveniently connect all BeamTuning elements to any optical set-up - without additional adjustment.

INTRA-SYSTEM

Intra-system a|Adapters allow to combine all BeamTuning elements, e.g. to use a|BeamExpander in both functional directions, to expand or reduce the beam diameter.

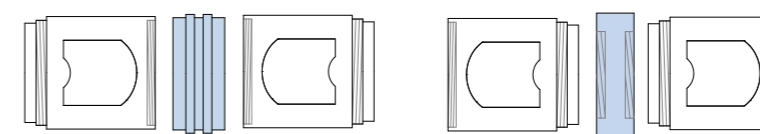

a|Adapter intra-system

a|Adapter 1.2" circumference

CROSS-SYSTEM

Easy integrate all BeamTuning elements into any optical system (e.g. Qioptiq, OWIS or Edmund Optics) through a variety of mounting concepts by using the cross-system a|Adapters (C-Mount, SM1). Thanks to its outer diameter, the 1.2" circumference can be used both as intra-system and as cross-system a|Adapter.

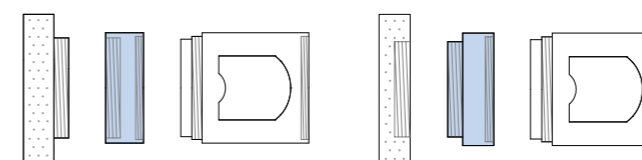

a|Adapter cross-system (female/female, male/female)

PRODUCT OVERVIEW ADAPTER TYPES

Adapter type	Product code	Thread type
C-Mount male	UAM25-28-C-MIO	male/female
C-Mount female	UAM25-28-C-MII	female/female
SM1 male	UAM25-28-SM1-MIO	male/female
SM1 female	UAM25-28-SM1-MII	female/female
Intra-System	UAM25-28-A-MOO	male/male
1.2" circumference	UAM25-28-1.2in-MII	female/female



NEW

Optomechanical components

TECHNICAL DIMENSIONS

C-MOUNT MALE

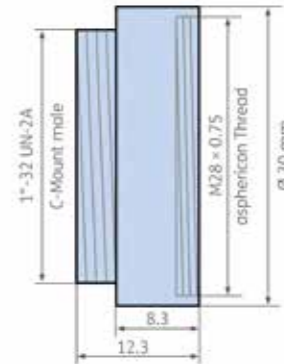

C-MOUNT FEMALE

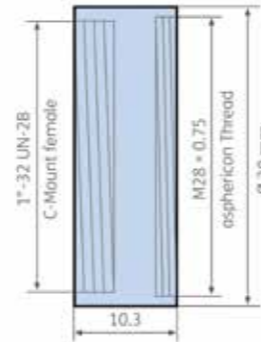

SM1 MALE

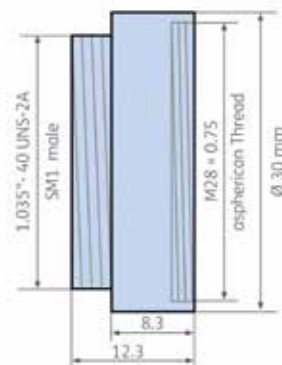

SM1 FEMALE

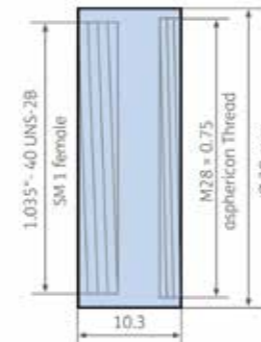

INTRA-SYSTEM

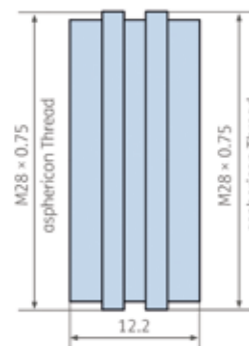

1.2" CIRCUMFERENCE (DUAL USE)

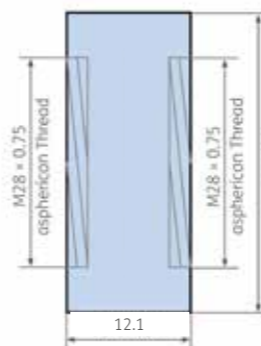

Discover how to precisely align optical elements in the beam path as well as reduce application-related tilts, saving additional adapters and reducing the length of your setup.

a|ADAPTER TILT

The a|Adapter tilt is infinitely tiltable in both the x and y directions thanks to its multi-joint design. It enables high flexibility when BeamTuning products are combined. If, for instance, tilting occurs in the beam due to the application, this intra-system a|Adapter allows products to be combined and also ensures they're precisely aligned in the beam path. It's technical dimensions can be found below.

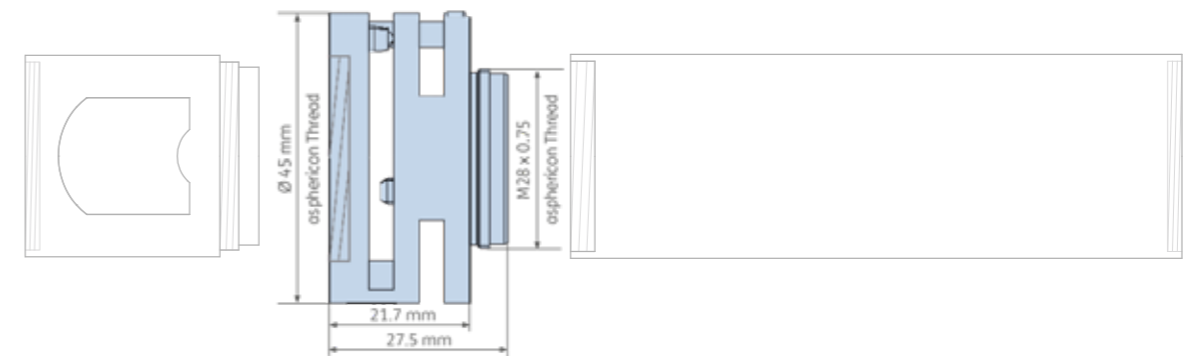

a|VARIMOUNT

When assembling optical set-ups for beam shaping, it can be challenging to align all the elements correctly without increasing the risk of tilting and decentering. The a|VariMount from asphericon can help.

This holder installs directly onto your mounting plate, allowing for perfect integration and alignment of components without additional adapters. It is available in three diameters (30, 50, 56.8 mm) and can be integrated into cage systems (30, 60 mm) and mounted on rail systems. Its design reduces stress peaks and deformations, making it easy to integrate even sensitive frames (e.g. aluminum alloys). The holder features centric threaded connections M4 and M6 for added flexibility to mount on posts. Simplify your work and achieve better results with the a|VariMount!

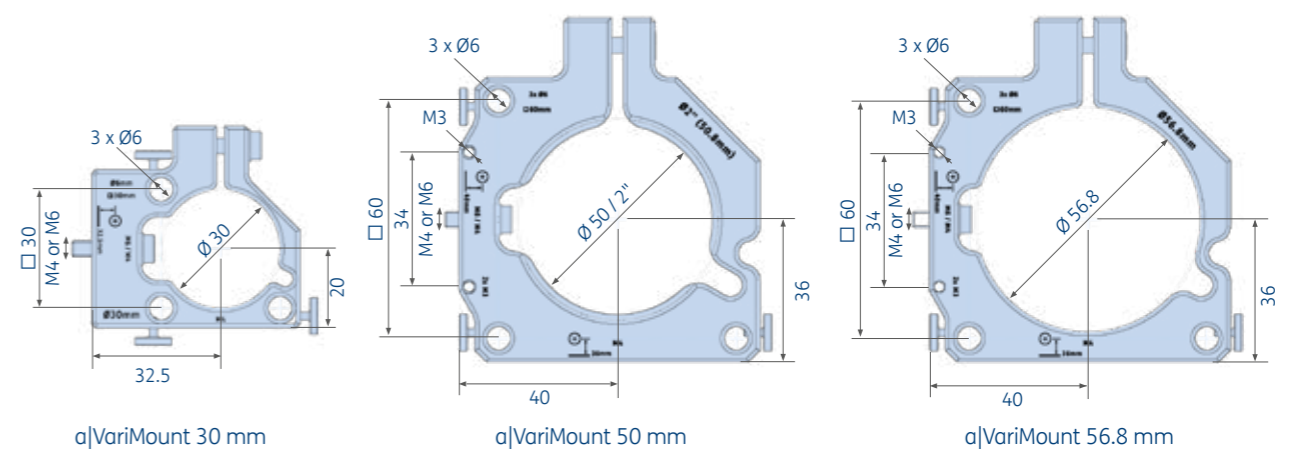

MountedOptics

Expand your laser application with the attractive selection of pre-aligned a|Aspheres and a|Axicons from the StockOptics product line in high-precision mounts.

All aspheres and axicons with diameters from 12.5 mm to 25.4 mm are perfectly aligned with $< 10 \mu\text{m}$ decentration of the optical and mechanical axis. Using the a|Adapters a very simple integration into any optical system is guaranteed.

- = a|MountedAspheres and a|MountedAxicons
- = Especially designed mounts, engraved with lens specifications
- = Perfect alignment ($< 10 \mu\text{m}$ decentration)
- = Tilt-reduced for optimal focusing
- = Modular design for high compatibility to all asphericon products and common optical systems
- = Comfortable and timesaving handling

**THREE
QUALITY LEVELS:**

**Rq up to
< 0.5 nm**

**AVAILABLE
WITH
HIGH-QUALITY
AR BROADBAND &
V-COATINGS**

TECHNICAL DIMENSIONS

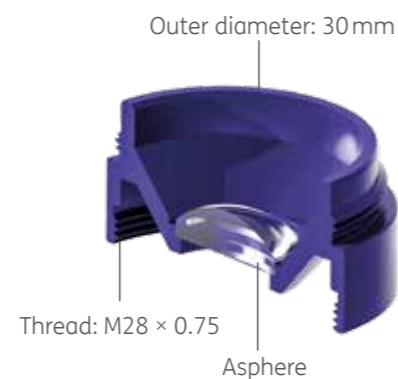

*Maximum usability
from asphericon.*



APPLICATIONS

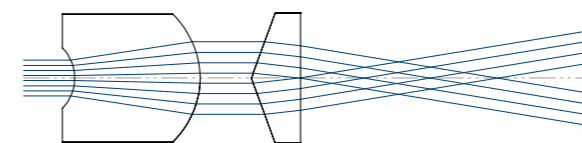

Optimizing the illumination of the axicon to adjust the length of the Bessel Beam.

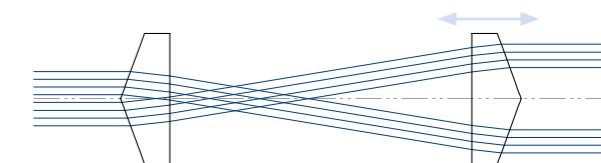

Generation of a collimated ring-shaped beam by altering the distance between the two axicons.

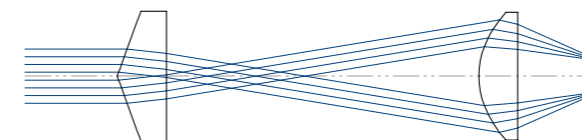

Generation of a ring focus - Distance changing through focal length of the lens, diameter changing through axicon angle.

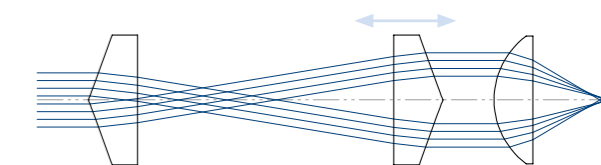

Changing the focal length of a sphere by altering the distance between the axicons and improving the performance.

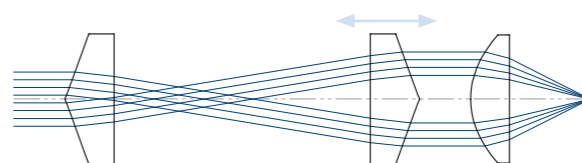

Changing the focus width of an asphere by altering the distance between the axicons - Focusing under the diffraction limit.

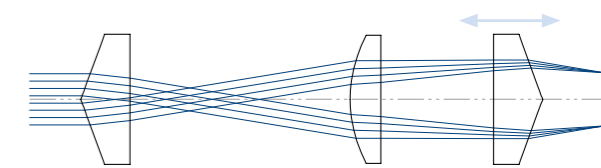

Generation of adjustable ring foci by shifting the last axicon to vary the ring diameters.

a|BeamBox

Mix & Match!

Regardless whether you need beam expansion, fiber collimation or beam shaping components: simply choose and combine them in one convenient a|BeamBox.

The following boxes are available:

- = Essential series: Including beam expansion elements for different wavelengths
- = a|TopShape & a|AiryShape series: Including beam expansion and shaping elements for different wavelengths
- = Mix & match, any combination is possible -
For your individual a|BeamBox, please contact us!



VARIATIONS

BeamBox	Possible content
a BeamBox Essential 355	1-8 BeamExpander 355 nm, Adapter
a BeamBox Essential 532	1-8 BeamExpander 532 nm, AspheriColl, Adapter
a BeamBox Essential 632	1-8 BeamExpander 632 nm, AspheriColl, Adapter
a BeamBox Essential 780	1-8 BeamExpander 780 nm, AspheriColl, Adapter
a BeamBox Essential 1064	1-8 BeamExpander 1064 nm, AspheriColl, Adapter
a BeamBox TopShape	1-5 BeamExpander, TopShape, AspheriColl, Adapter, MountedAspheres/Axicons
a BeamBox (Sq)AiryShape	1-6 BeamExpander, (Sq)AiryShape, AspheriColl, Adapter, MountedAspheres

a|BEAMBOX ESSENTIAL

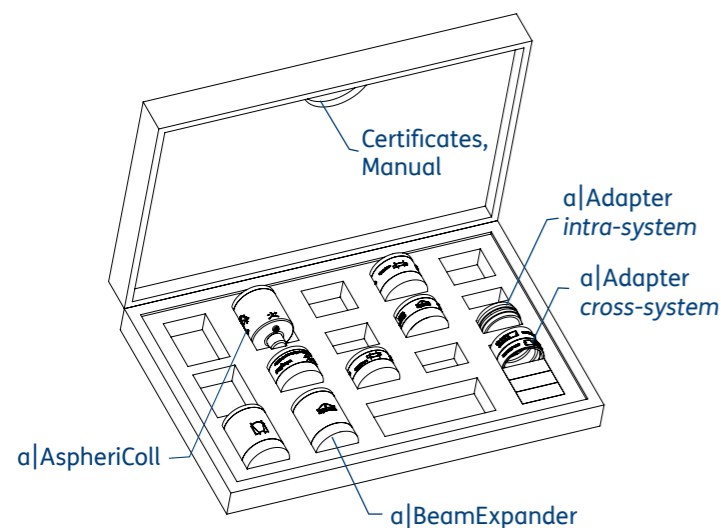

a|BEAMBOX TOPSHAPE/AIRYSHAPE

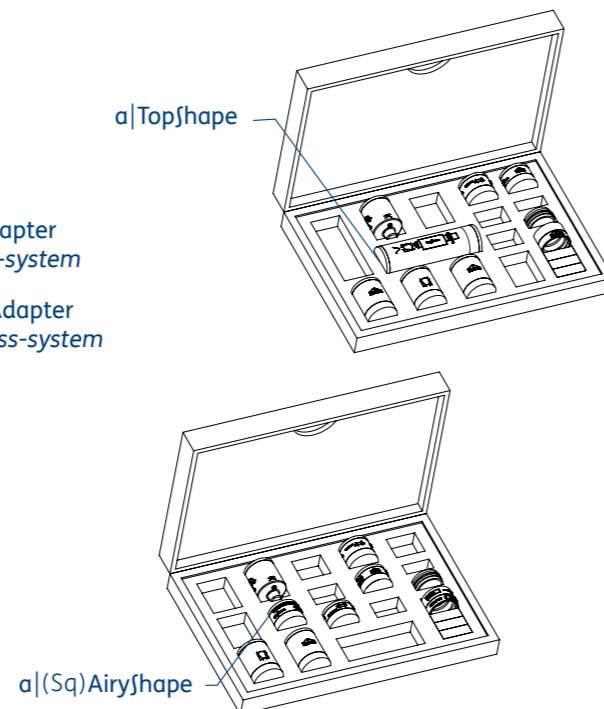

BEAMEXPANSION

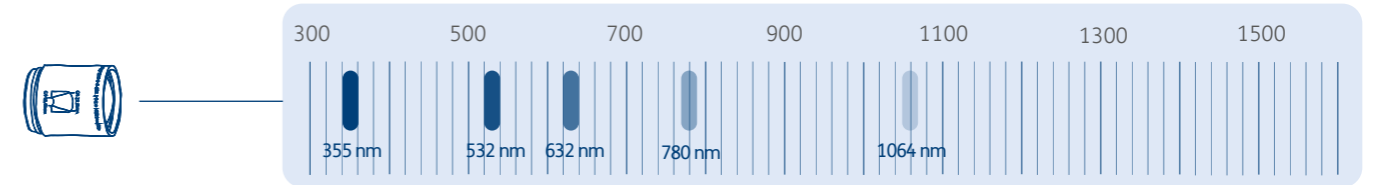

FIBERCOLLIMATION

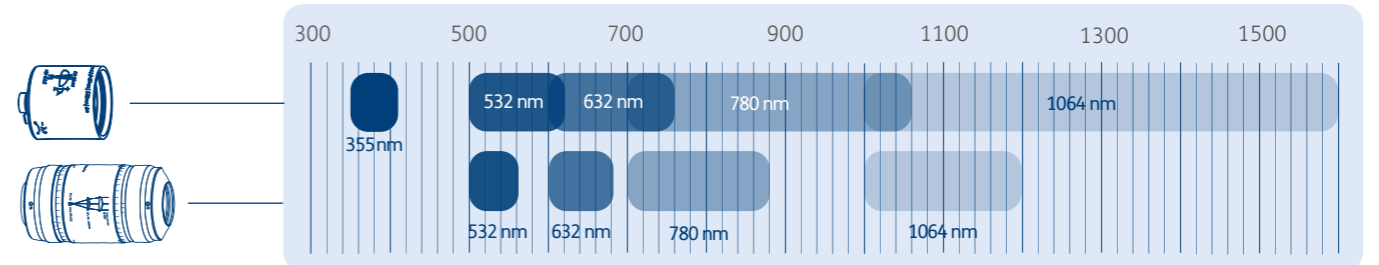

BEAMSHAPING

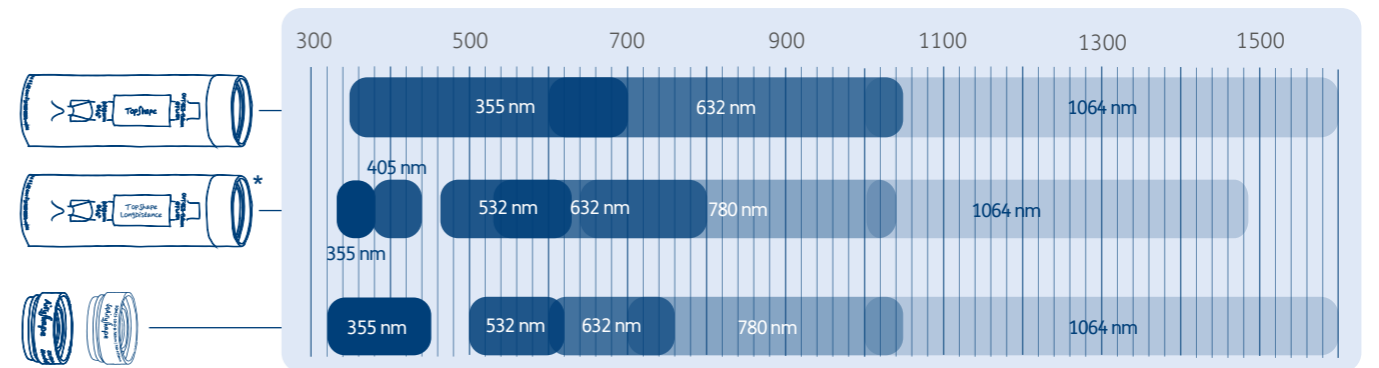

* For a|TopShape LD and LDX wavelength ranges refer to WD 1000 mm. Respective coatings cover a wider range.

COMPLEMENTARY ELEMENTS

MountedOptics



Adapters

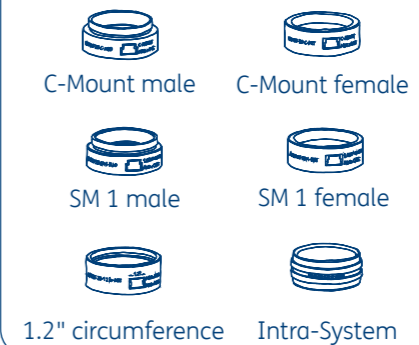

Opto-Mechanics



BeamTooling App

asphericon BeamTooling is the ultimate tool for the perfect usage of BeamTuning products. Whether for applications in the lab or in the field, with this app you will find quickly and easily solutions at any time.



asphericon GmbH

 +49 (0) 3641 - 31 00 500

 +49 (0) 3641 - 31 00 501

 sales@asphericon.com

 www.asphericon.com

Stockholmer Straße 9
07747 Jena
Germany

asphericon, Inc.

 +1 941 564 0890

 info@asphericon-inc.com

 www.asphericon.com

2601 Cattlemen Road,
Suite 301
Sarasota, FL 34232 | USA

asphericon s. r. o.

 +420 488 100 300

 sales@asphericon.cz

 www.asphericon.com

Miliřská 449,
Jeřmanice 463 12
Czech Republic

